

AnyTone[®]

Qixiang Electron Science & Technology Co., Ltd.
www.anytone.net

AnyTone[®]

AT-D868UV

**Digital DMR and Analog
UHF/VHF Two Way Radio**

Operating Manual



DMR
DIGITAL MOBILE RADIO ASSOCIATION

THANK YOU!

Thank you very much for choosing our *AnyTone* Dual Band Digital DMR and Analog two way radio.

This radio adopts the latest advances in technology, providing reliable communication in today's demanding communication environment.

This radio offers both DMR digital and analog communication, introduces innovative DMR digital processing system to achieve SMS, high-audio quality and digital encryption. It offers great stability, and reliability, together with long distance communication as well as fashionable design and compact exterior lines. AT-D868UV has Text message, recording, voice message, digital encryption, emergency alarm, Man down alarm, lone work, GPS with APRS, Vibration and Analog DTMF, 2TONE, 5TONE, CTCSS/DCS encode/decode functions.



NOTE

» **When programming the radio, start by reading the factory software data, and then rewrite this data with your frequency etc., otherwise errors may occur because.**

» **You can use the programming cable with a PC to program the frequency, channel type, power etc. your programming must comply with your FCC (or other country) license certification.**

Notice to the User

1. Keep the radio and accessories away from children.
2. Please do not try to open or modify the radio unless authorized, non-professionals repair may cause damage and void the warranty.
3. Please use the AnyTone battery and charger to avoid damage.
4. Please use the supplied antenna to ensure good communication.
5. Please do not expose the radio to direct sunlight for a long period of time or place the radio near excessive heat.
6. Please do not put the radio in extremely dusty or humid areas.
7. Do not use harsh chemicals, cleaning solvents to clean the radio.
8. Absolutely do not transmit without the antenna installed on the radio.
9. When using this radio, we recommend transmitting for 1 minute then receiving for 4 minutes. Continuously transmitting for a long time or working with the high power setting will heat the back of the radio. Do not place the radio's hot side close to any surface of plastic.
10. If abnormal odor or smoke is detected from the radio, power off the radio and remove the battery pack. Then contact your local AnyTone dealer for advice.

ATTENTION:

- » **The above also applies to accessories for your AnyTone two way radio. If any item is not working normally, please contact your local AnyTone dealer.**
- » **Accessories made by other companies are not guaranteed by AnyTone to operate correctly and to keep the radio working safely.**

CONTENTS

1.UNPACKING AND CHECKING THE EQUIPMENT.....	1
1.1 Supplied Accessories.....	1
1.2 Standard Accessories.....	2
1.3 Optional Accessories.....	2
2.BATTERY INFORMATION.....	3
2.1 Charging the Battery Pack.....	3
2.2 Charger Supplied.....	3
2.3 Use Caution with the Li-ion Battery.....	3
2.4 How to Charge.....	4
2.5 Normal Charging Tips.....	5
2.6 How to Store the Battery.....	6
3. PREPARATION.....	7
3.1 Installing / Removing the Battery.....	7
3.2 Installing / Removing the Antenna.....	7
3.3 Installing / Removing the Belt Clip.....	7
3.4 Installing the Additional Speaker/Microphone (Optional).....	8
4. Radio Overview.....	9
4.1 LED Indications.....	10
4.2 Programmed Key.....	11
4.3 Default function.....	12
4.4 Hot Key.....	12
5.BASIC OPERATIONS.....	13
5.1 Power on the Radio.....	13
5.2 Adjust Volume.....	12
5.3 Battery Voltage Test.....	13
5.4 Main band/Sub band switch.....	13
5.5 VFO/Channel switch.....	13
5.6 Set up VFO frequency.....	13
5.7 Select a Zone.....	14
5.8 Select a Channel.....	14

5.9 Receiving and Responding to a Radio Call	15
5.10 Temporary Monitor	16
5.11 Monitor	16
6. ADVANCED FEATURES	17
6.1 Advanced Features for Private Call	17
6.2 Advanced Features	17
7.GPS POSITIONING FUNCTION	19
7.1 Turn on GPS	19
7.2 Check the GPS Information	19
7.3 Send GPS Information	19
7.4 Man Down Alarm.....	20
8.RECORDING.....	21
8.1 Turn on/ off the Recording	21
8.2 Play the Record	21
8.3 Send the Record.....	21
8.4 Recording Manually	21
9.MAIN MENU.....	23
9.1 Contacts.....	23
9.2 Messages.....	23
9.3 Call Log.....	23
9.4 Scan List	23
9.5 Settings	24
9.5.1 Radio Set.....	24
9.5.2 Chan Set.....	27
9.5.3 Device Info.....	30
10.TROUBLE SHOOTING GUIDE.....	31
11.PROGRAMMING GUIDE	32
12.ON-LINE SERVICE AND SUPPORT	34
13.TECHNICAL SPECIFICATIONS	37

1. UNPACKING AND CHECKING THE EQUIPMENT

Unpack the radio carefully. We recommend that you identify the items listed in the following table before discarding the packing materials. If any items are missing or have been damaged during shipment, please contact the carrier or the dealers immediately.

1.1 Supplied Accessories

Item	Number	Quantity
Antenna		1
Li-ion Battery Pack		1
Battery Charger		1
AC Adaptor		1
Belt Clip		1
Hand Strap		1
Instruction Manual		1

1. UNPACKING AND CHECKING THE EQUIPMENT

1.2 Standard Accessories

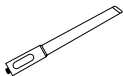

Antenna*¹



Li-ion Battery Pack



Charger



AC Adaptor



Belt Clip



Instruction Manual

* **Note:** For frequency band of antenna, please refer to label indicated in the bottom of the antenna.

* **Note:** Car Charger and QBC-45L Charger should be used together.

1.3 Optional Accessories



USB Programming



Earphone



Li-ion Battery Pack



Programming Software



Car Charger

2. BATTERY INFORMATION

2.1 Charging the Battery Pack

The Li-ion battery pack is not charged at the factory; please charge it before use.

Charging the battery pack for the first time after purchase or extended storage (more than 2 months) may not bring the battery pack to its normal maximum operating capacity. Best operation will require fully charging/discharging the battery two or three times before the operating capacity will reach its best performance. The battery pack life may be depleted when its operating time decreases even though it has been fully and correctly charged. If this is the case, replace the battery pack.

2.2 Charger Supplied

Please use the specified charger provided by AnyTone. Other models may cause explosion and personal injury. After installing the battery pack, and if the radio displays low battery with a red flashing lamp or voice prompt, please charge the battery.

2.3 Use Caution with the Li-ion Battery

- a.** Do not short the battery terminals or throw the battery into a fire. Never attempt to remove the casing from the battery pack, as AnyTone cannot be held responsible for any accident caused by modifying the battery.
- b.** The ambient temperature should be between 5°C-40°C (40°F - 105°F) while charging the battery. Charging outside this range may not fully charge the battery.
- c.** Please turn off the radio before inserting it into the charger. It may otherwise interfere with correct charging.
- d.** To avoid interfering with the charging cycle, please do not cut off the power or remove the battery during charging until the green light is on.
- e.** Do not recharge the battery pack if it is fully charged. This may shorten the life of the battery pack or damage the battery pack.
- f.** Do not charge the battery or the radio if it is damp. Dry it before charging to avoid damage.

2. BATTERY INFORMATION

WARNING:

» When keys, ornamental chain or other electric metals contact the battery terminal, the battery may become damage or injure a human. If the battery terminals are short circuited it will generate a lot of heat. Take care when carrying and using the battery. Remember to put the battery or radio into an insulated container. Do not put it into a metal container.

2.4 How to Charge

- a. Plug the AC adaptor into the AC outlet, and then plug the cable of the AC adaptor into the DC jack located on the back of the charger. The indicator light blinks orange and is then ready to charge a battery.
- b. Plug the battery or the radio into the charger. Make sure the battery terminals are good in contact with charging terminals. The indicator light starts to blink red--- Pre-charging begins.
- c. After pre-charging for about 5 minutes, the red indicator will stop blinking--- charging begins.
- d. It takes approximately 2-5 hours to fully charge the battery. When the lamp lights green, the charging is completed. Remove the battery or the radio unit with its battery from socket

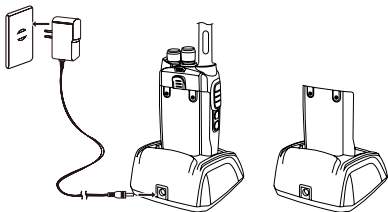





NOTE

» when charging a radio (with battery) the indicating lamp will not turn into green to show the fully charged status if the radio is powered on. Only when the radio is switched off will the lamp indicate normal operation. The radio consumes energy when it is power-on, and the charger cannot detect the correct battery voltage when the battery has been fully charged. So the charger will charge the battery in constant voltage mode and fail to indicate correctly when the battery has been fully charged.

2. BATTERY INFORMATION

e. Charging Process

Charging Status		Indicator Status
Standby (Self-examine lights orange 1second when power on)		None
Pre-charging (Pre-charging stage)		Red light twinkles for about 5 minutes
Charging (Charge in a constant current)		Lights red for about 5 hours
Fully charged (Charge in a constant voltage)		Lights green

f. LED Indicator:

STATUS	LED
Self-Examine When Power on	Orange (for 1 second)
No Battery	None
Pre-charging	Red Light Twinkles for 5 Minutes
Charge Normally	Red
Fully Charged	Green
Trouble	Red twinkles for a long time

 » **Trouble means battery too warm, battery short-circuited or charger short-circuited.**
NOTE

2.5 Normal Charging Tips

- a. Self-Test:** When powering on the charger, the orange light blinks and stays off, which means the charger has passed its self-test and it is ready to charge the battery. If the light remains orange or the red light blinks, it means the charger cannot pass its self-test and cannot charge the battery.
- b. Trickle Pre-Charging:** If red light blinks when the battery is inserted into the charger, it means that the battery voltage is low and the charger is trickle-charging the battery (Pre-Charging Mode). The charger will automatically turn into normal charging when the battery reaches a certain electric charge, and if the red light stops blinking, it means the battery voltage has reached a certain level, and the charger will charge the battery in normal mode.

2. BATTERY INFORMATION



NOTE

» Trickle charging (Pre-Charging Mode) time cannot last beyond 30 minutes. If the indicating lamp still blinks red after 30-minute trickle-charging, it means that the charger cannot charge the battery correctly. Please check whether the battery or charger is damaged.

2.6 How to Store the Battery

- a. If the battery needs to be stored, keep it in status of 80% discharged.
- b. It should be kept in low temperature and dry environment.
- c. Keep it away from hot places and direct sunlight.



NOTE

- » Do not short circuit the battery terminals.
- » Never attempt to remove the casing from the battery pack.
- » Never store the battery in unsafe surroundings, as a short may cause an explosion.
- » Do not put the battery in a hot environment or throw it into a fire, as it may cause an explosion.

3. PREPARATION

3.1 Installing / Removing the Battery

- Match the two bottom grooves of the battery pack with the corresponding guides on the back of the radio and then push it.
- To remove the battery pack, slide the release latch at the top away from the battery and remove the pack away from the transceiver.

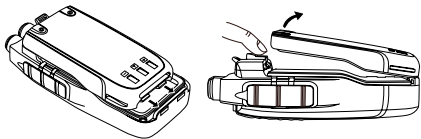

3.2 Installing / Removing the Antenna

- Installing the Antenna: Screw the antenna into the connector on the top of the transceiver by holding the antenna at its base and turning it clockwise until secure.
- Removing the Antenna: Turn the antenna counter-clockwise to remove it.

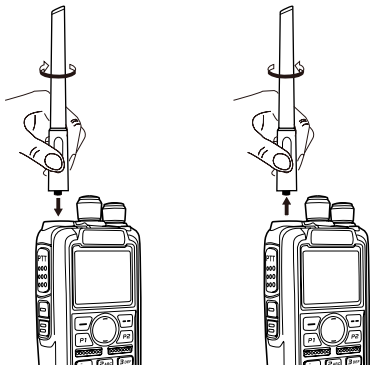

3. PREPARATION

3.3 Installing / Removing the Belt Clip

- a. Installing the Belt Clip: Place the belt clip above the corresponding holes on the back of the radio, and screw it into place clockwise with the two supplied screws.
- b. Removing the Belt Clip: Unscrew counter-clockwise to remove the belt clip.

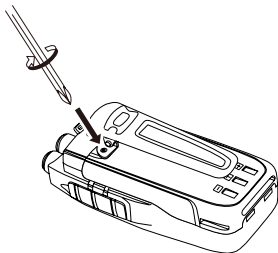

3.4 Installing the Additional Speaker/Microphone (Optional)

Pry open the rubber MIC-Headset jack cover and then insert the Speaker / Microphone plug into the double jack.

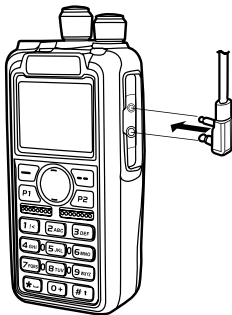

4. RADIO OVERVIEW

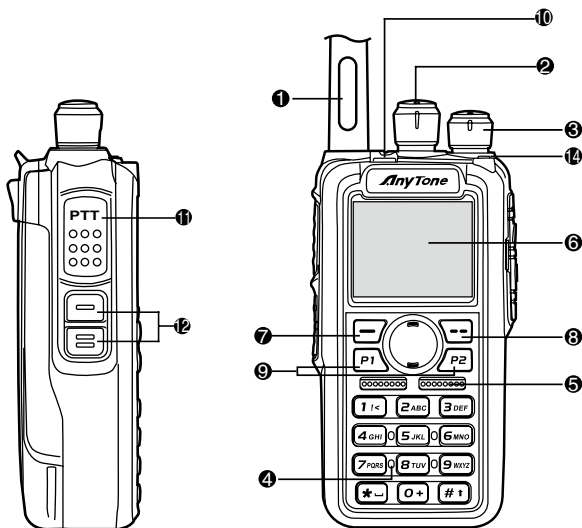

① Antenna

② Channel Switch

③ POWER/VOLUME Switch

Turn clockwise to switch on the radio

Turn counterclockwise till a click is heard to switch off the radio.

Rotate to adjust the volume after turning on the radio.

④ MIC Input

Please keep your mouth about 10cm away from the microphone to achieve the best voice quality.

⑤ Speaker

⑥ LCD

Display the frequency/channel information, operation and status.

4. RADIO OVERVIEW

7 Menu key

Press to enter function menu set up;

Program the hot keys in PC software, press menu key, then press the hot key to perform the programmed function.

8 Exit Key

In standby, press the key to enter the Contact list.

In menu, press the key to return the last menu.

9 P1 key/ P2 key

Programmable in PC software for different functions

10 Emergency Alarm Key

Programmable in PC software for other functions.

11 PTT (Push-To-Talk) Button

To make a call, press and hold the PTT button, then speak into the microphone. Release the button to receive the signals.

12 [PF1]/[PF2] Key

Programmable in PC software for different functions.

13 Speaker/Microphone Jacks. PC program connector

14 Status Indicator

Indicate the different working status.

4.1 LED Indications

The top LED will help you to identify the current radio status.

LED Indication	Status
Flashes Red	Low battery voltage
Constant Red	Transmitting
Constant Green	Analog Receiving
Constant Cyan	Digital Receiving
Flashes Green	Scan

4. RADIO OVERVIEW

4.2 Programmed Key

In PC software – Public - Optional Setting - Key function, it is possible to set different functions for [PF1], [PF2], [PF3], $\boxed{P1}$, $\boxed{P2}$ keys.

OFF	No Function
Voltage	Check the current battery capacity voltage
Power	Switch the power between super high, high, middle and low power.
Repeater	Switch between talk around and repeater mode
Reverse	Turn on/off the frequency reverse function.
Digital Encryption	Choose the encryption group
Call	In Analog mode, send the DTMF/5TONE/2TONE encode. This function is only valid for analog channel.
TBST	In Analog mode, send the tone pulse frequency signal to active the repeater.
VOX	Set up the VOX level
VFO/MR	Switch between VFO mode and memory channel mode.
Sub PTT	Sub channel PTT, press to start the call on sub channel
Scan	Scan on/off
FM Radio	FM radio on/off
Alarm	Long press the key to start alarm, short press again to exit the alarm.
Record switch	Enable/disable the recording function
Record	Start/stop recording. When stop recording, the radio will remind repeat or send the record.
SMS	In digital mode, press to enter into messages
Dial	Start the manually dial
GPS	Check the GPS position information
Monitor	Monitor the weak signal or the signal with unmatched ID.
Main channel switch	Choose channel A or channel B as the main channel
Hot key 1~6	Press the key to perform the programmed function in hot key setup
Alone	Turn on/off the work alone function.

4. RADIO OVERVIEW

4.3 Default function

[PF1] (The radio key below PTT) – battery Voltage



[PF2] (The radio key 2 below PTT) – Monitor

[PF3] (Orange Alarm key) –Alarm

[P1] key – Main channel Switch

[P2]key – VFO/MR Switch

4.4 Hot Key

In PC software – Public – Hot key, it is able to set different functions for hot key  and + number key. For details please refer to the PC software.

Call	Analog	Should edit the analog quick call first, then choose analog in the hot key set. Press the key to transmit 2Tone/5Tone/DTMF to start the analog quick call.
	Digital	It allows to select a contact from the digital contact list, press the key to switch the channel to the contact temporary. It will switch back to the original contact after the group/personal call hold time.
Menu	SMS	Quick access to Messages in the menu
	New Msg	Quick access to New Msg in the Menu - Messages
	Quick Text	Quick access to Quick Text in the Menu - Messages
	Inbox	Quick access to Inbox in the Menu - Messages
	Outbox	Quick access to Out box in the Menu - Messages
	Contact list	Quick access to Contact list in the Menu - Contacts
	Manual dial	Quick access to Manual Dial in the Menu - Contacts
	Call Log	Quick access to Call Log in the Menu
	Sent Calls	Quick access to Dialed Calls in the Menu - Call Log
	Answered Calls	Quick access to Answered Calls in the Menu - Call Log
	Missed Calls	Quick access to Missed Calls in the Menu - Call Log
	Zone	Quick access to Zone in the Menu
Radio set	Quick access to Radio Set in the Menu - Settings	

+ number key operation:

Press  key until the LCD display “Next Please Press Dial Key”, press the number key, it will perform the programmed function.

5. BASIC OPERATIONS

5.1 Power on the radio

Turn on the radio by turning the [Power/Volume] switch clockwise till a click is heard, and the LCD displays will show a start-up message, and you will hear a beep after 7seconds.

5.2 Adjust Volume

Rotate the [Power/Volume] knob to adjust the volume. Turn clockwise to increase the volume and counterclockwise to decrease the volume. The LCD display will show the volume status during an adjustment.

5.3 Battery Voltage Test

Press the [PF1] key to check the current battery voltage, then press the key again to return.

5.4 Main band/Sub band switch

Press the  key to switch the main channel to the other channel if there is 2 channels shown on the display. The channel with bold characters is the main channel.

5.5 VFO/Channel switch

Press the  key to switch between VFO and channel display.

 » If the Channel is set to display a Channel name, this function is
NOTE invalid.

5.6 Set up VFO frequency

Turn the radio to VFO mode, press the  key to switch the channel to main band, the VFO frequency can only be set up when the channel is the main “bold text” channel.



Operation 1: Input the VFO frequency directly by the keyboard.

Operation 2: Turn the channel selector to adjust the VFO frequency steps.



5. BASIC OPERATIONS



5.7 Select a Zone

A Zone is a group of channels grouped together. The D868UV DMR radio has 250 Zones. A Zone can have the maximum of 160 analog and/or digital channels.

Operation 1: Press  /  directly to switch the zone, the LCD will display the selected zone number or name.



Operation 2:

(1) Press the Menu, press  /  to select Zone.

(2) Press Select to enter Zone, press  /  to a Zone.

(3) Press Select to enter a Zone.

Edit Name: Input the name, press confirm, and it will exit the Edit name and ask to Save the name, press select to save the name, and it will display "Saved".

Select Zone: Press  /  to "Select Zone", press select, the LCD will display the selected zone number or name.

5.8 Select a Channel

Operation 1: Turn the channel switch to select a channel.

Operation 2: Press  key to switch the radio to Channel mode, input the channel numbers by the keyboard. For example, if you want switch to channel 99, input 0+0+9+9 a total of 4 digits, and it will switch to channel 99.

A channel can either be Analog or Digital.

For the analog channels the Push-To-Talk button is always available, and on the Digital Channels parameters can be set up by the users / system operators by channel to allow talk permit. There are four possible settings:

(1) Always Allow: The user can transmit all the time.

(2) Channel Free: The radio can transmit only if the channel is free.

(3) Different Color Code: The radio can transmit if the channel is free, but the color code is mismatch.

(4) Same Color Code: The radio can transmit only if the channel is free and the color code matches.

5. BASIC OPERATIONS

5.9 Receiving and Responding to a Radio Call

When the radio is in the digital mode, it can receive and respond to a call with the same frequency/color code/ slot.

When receiving a call:

- a. If the radio is programmed with callers DMR ID number in the digital contact list, when receiving a call, the radio will ring or vibrate briefly.
- b. The blue LED lights up.
- c. The left top corner of LCD shows the **RSSI** icon, and the LED display will show DMR ID/name/city/state/country/call type and incoming icon based on what is in the contact list.
- d. When the call is ended, it will display "Call end", and you can press [PTT] to respond the call.

Making a Call



You can choose a target radio via 3 methods.

Method 1: from the Channel switch.

Turn the channel switch to choose a programmed channel.

Method 2: from the Contact list.

(1) Turn the channel switch to choose a programmed channel;

(2) Press  (exit) key to enter the Contact List, press the  /  key to choose a contact.

Method 3: from the keypad.

(1) Turn the channel switch to choose a programmed channel.

(2) Press  (Menu) key to Contacts, press select to enter Contacts.

(3) Press  /  key to Manual Dial, press Select.

(4) Input the ID number by keypad, press  key to switch group ID or Private DMR ID.

Hold the radio vertical 2.5-5cm from your mouth, press the [PTT] key to start the call, the red LED lights up, the receiver ID/name/city/state/country/call type and call out icon will be display on the LCD.

Release [PTT] key to receive the reply.

5. BASIC OPERATIONS

5.10 Temporary Monitor

In standby, press and hold the [PF2] key to enter Temporary Monitor. When receiving matched carrier but the signaling / ID is unmatched or the signal is too weak, this function allows monitor the weak signal and signal with unmatched ID.

Release the [PF2] key to shut off speaker and return to standby.

 » **In the PC software, Public - Optional Setting - Other - Mon Key Function should be set up to Squelch Off Momentary.**

5.11 Monitor

In standby, press the [PF2] key to enter Monitor. When receiving matched carrier but the signaling / ID is unmatched or the signal is too weak, this function allows monitor the weak signal and signal with unmatched ID.



Press the [PF2] key again to shut off speaker and return to standby.

 » **In the PC software, Public - Optional Setting - Other - Mon Key Function should be set up to Squelch Off.**



6. ADVANCED FEATURES

6.1 Advanced Features for Private Call

Method 1: Access from Contact list

- a. Press the  (Exit) key to enter the Contact list, press the  /  key to a private call ID name.
- b. Press Select to View Contact, press Select to see the contact information.
- c. Press Option to access the advanced features.

Method 2: Access from Manual Dial

- a. Press the  (Menu) key to enter Contacts, press  /  key to Manual Dial.
- b. Press Select to enter Manual Dial.
- c. Input the Private ID, press Option to access the advanced features.

6.2 Advanced Features

(1) Call Alert

Select Call Alert, it will send out a call alert, the target radio will sound a beep or vibrate when receiving the call alert, and it will return a success call or failed call message to the transmit radio.

(2) Remote Monitor

Select Remote Monitor, and it will send out a signal for the target radio will turn on its microphone and transmit when receiving the signaling, it will send back the voice to the transmit radio. With this feature you can monitor the sound activity near the target radio remotely.

(3) Get GPS info

Select Get GPS info, and it will send out a signal to the target radio which will start the GPS positioning and send a message of its GPS position to the transmit radio.

(4) Check Radio

Select Check Radio, and it will send out a radio check to the target radio which will send back a message if it is available or not available to the transmit radio. With this feature, you can determine if another radio is active and powered on in the system.

6. ADVANCED FEATURES

(5) Kill







Select Kill, and it will send out a kill signaling to the target radio which will be killed (No display, no operation) when receiving the signaling and it will send back a kill successful message to the transmit radio.

(6) Wake

Select Wake, and it will send out a wake signaling to the killed radio and the target radio will return to standby when it receives this signaling and send back a Wake successful message to the transmit radio.



7. GPS POSITIONING FUNCTION

7.1 Turn on GPS

- a. Press  (Menu) to enter the main Menu, press  /  key to Settings.
- b. Select Radio Set, press the  /  key to GPS Set
- c. Select GPS Set, press  /  key to GPS On
- d. Select GPS On.

7.2 Check the GPS Information

Method 1: Check GPS info from Menu

Press  (Menu) key to enter Main Menu, press  /  key to GPS info, press select to check the GPS info.

Method 2: Check GPS info from programmed key

In the PC software, Public – Optional Setting – Key function, program a key as GPS, press the programmed key to check the GPS info.

 » **If the GPS is not positioning, it will display “No Fixed Position”, and the GPS icon shows a grey color. Move the radio to an open window or outdoors, and it will take a few minutes to connect to the GPS Satellites.**





NOTE

7.3 Send GPS Information

- a. When the GPS is positioning successfully, the GPS icon shows a red color. Follow the above step to check the GPS info, press edit key to Text edit.
- b. Press Confirm, and it will display Send or Save. If you select Save, the GPS info will be saved as a draft message.
- c. Choose Send and it will display Contact list or Manual Dial.
- d. Select Contact list to choose a contact, press select to send the GPS info. or
- e. Select Manual Dial, input the DMR ID, press  key to switch group ID or private ID, press select to send the GPS info.

7. GPS POSITIONING FUNCTION

7.4 Man Down Alarm

- a. Press  (Menu) to enter main Menu, press  /  key to Settings.
- b. Select Radio Set, press  /  key to 25 Man Down.
- c. Select Man Down On to turn on the function.



When the function is on, the radio will start alarm if the radio is falling to the ground. Raise the radio to stop the alarm.

 » **When GPS is on and positioning successfully, it will auto send out the GPS information when the radio starts the alarm.**



NOTE

8. RECORDING





8.1 Turn on/ off the Recording

- a. Press  (Menu) enter main Menu, press  /  key to Record.
- b. Select Record Switch, select on or off to turn on or off the Record.
When the function is on, the radio will record the talking during the communication.

8.2 Play the Record

- a. Press  (Menu) to enter main Menu, press  /  key to Record.
- b. Select Record List to enter Record list, select a Record list to enter the Record file.
- c. Select a Record to see the detail information.
- d. Select Record Play to play the record.

8.3 Send the Record

- a. Press  (Menu) to enter main Menu, press  /  key to Record.
- b. Select Record List to enter Record list, select a Record list to enter the Record file.
- c. Select a Record to see the detail information.
- d. Select Record Send, and it will display the Contact list or Manual Dial.
- e. Select Contact list to choose a contact, press select to send the Record.
- f. Select Manual Dial, input the DMR ID, press  key to switch group ID or private ID, press select to send the Record.

8.4 Recording Manually

In the PC software, Public – Optional Setting – Key function, program a key as Record.

- a. Press the programmed Record key, and the radio will start the recording, and speak into the microphone.
- b. Press the programmed Record key again to stop the recording, and the radio will display Record Play or Record Send.
- c. Select Record Play, and the radio will play the record.
- d. Select Record Send, and the radio will display Contact list or Manual Dial.

8. RECORDING

- e. Select Contact list to choose a contact, and press select to send the Record.
- f. Select Manual Dial, input the DMR ID, press **#1** key to switch group ID or private ID, press select to send the Record.



» **The Recording function is only valid in digital channel.**

NOTE

9. MAIN MENU

9.1 Contacts

Contacts List: Will display the digital contact list which had been programmed in the PC software. This list is used as a look-up table to display the contact person information when receiving a call.

New Contact: Allows to create a new digital contact.

Manual Dial: Input the group ID or private ID to access a contact quickly.

9.2 Messages

New Msg: Create a new message and send to a contact.

InBox: Shows all the received messages, and allows forward or delete the message.

OutBox: Shows all the sent messages, and allows resend, forward or delete of the message.

Quick Text: Pre-saved messages, and allows to send, edit or delete the message.

Draft: Draft messages, and allows send, edit or deleting of the message.

9.3 Call Log

Sent: Shows all the dialed calls, and allow deleting the call record or saving the ID as a new contact.

Answered: Shows all the answered calls, and allows deleting the call record or saving the ID as a new contact.

Missed: Shows all the missed calls, and allows deleting the call record or saving the ID as a new contact.

9.4 Scan List

In the PC software – Public – Scan list, it allows to save 250 scan lists, and to program the required scan lists and write it into radio.

Switch the radio to channel mode, as the scan list is only valid in the channel mode.

Select a Scan list as current scan list, then you can also reset the priority channel 1 and priority channel 2 in the scan list.

9. MAIN MENU

9.5 Settings

9.5.1 Radio Set

(1) Beep

Beep On: The radio will beep when you press the keypad

Beep Off: No beep when you press the keypad.

(2) Back Light



LCD backlight intensity is adjustable in 5 steps

(3) Ch. Name

CH name: The radio will work in channel mode and display the channel name, and then the programmed VFO/ MR key is not valid.

Frequency: The radio will work in VFO mode and display the frequency, which allows the programmed VFO/MR key to switch the VFO and Memory channels.

(4) Key Lock

Manual Lock: Long press the  key to lock the keypad. Press Func key, then press the  key to unlock the keypad.

Auto Lock: Radio will auto lock the keypad when standby for a while. Press [Func] key, then press the  key to unlock the keypad

(5) Power Off

Allow to set automatic power off when not used for a period of 10 minutes, 30minutes, 1 hour or 2 hours of inoperation.

Off: Turn off the function.

(6) TX Timer

30S-240S: The TX will be limited in the set time. When this time is reached, the radio will auto stop transmission.

OFF: Turn off the TX time limit, and there is no limit for the transmission time.

(7) Language

Choose the Chinese or English.

(8) Menu Exit Time

5S-20S: When enter the menu, the radio will stay at the menu in the set time. When the time is reached, the radio will auto exit the menu.

(9) Intro Display

Picture: The radio will display an AnyTone picture when powered on.

Character: The radio will display the characters set up in PC software when powered on.

9. MAIN MENU

(10) Main Ch

Channel A: The upper displayed channel will be set to be the main channel.
Channel B: The lower displayed channel will be set to become the main channel.

(11) Sub Ch

Sub Channel On: Turns on the sub channel, and the radio will display both channel.

Sub Channel Off: Turns off the sub channel, and the radio will display the main channel only

(12) Msg Note

Different prompt options when receive a new message.

(13) Call Ring

Different prompt options when receive a new call.

(14) Freq Step

2.5K,5K,6.25K,10K,12.5K,20K,25K,30K,50K, a total of 9 frequency steps offered.

(15) SQ level

Adjusts the squelch level to receive signal with different signal strength, and a total of 5 levels offered. This function is only valid for analog channel.

(16) Power Save

Turn on the function to extend the battery life.

(17) TBST Sel

TBST frequency is used to activate some dormant repeaters, 1000Hz, 1450Hz,1750Hz, 2100Hz a total of 4 options are offered.

(18) VOX

Enable the VOX, you can speak into the microphone to start transmitting instead of pressing the [PTT] key. A total of 3 levels are provided.

(19) VOX Delay

When the VOX is enabled, set up the VOX delay to help to extend the transmission time to avoid stopping a transmission too early. 0.5s-3s, a total of 26 times offered.

(20) Scan Mod

SCM TO: When scanning and stopping for a signal, stays at the channel 5s before resuming the scan.

9. MAIN MENU

SCM CO: When scanning and stopping for signal, stays at the channel until the signal disappears, and resumes scan 2s later.

SCM SE: When scanning and stopping for a signal, will terminate the scan. This function is only valid for a VFO scan.

(21) Mic Level

Allows to adjust the Microphone gain, level 1 is the lowest, level and 5 is highest gain.

(22) DTMF Speed

Offers DTMF encode speed which will help the receiver decode successfully, 50~500ms are the options.

(23) FM Radio

Turn on or off the FM radio.

(24) FM Radio Moni

Radio Mon On: When FM radio is used, you can still receive or transmit on the channel.

Radio Mon Off: When FM radio is used, the radio will not permit a transmission or reception.

(26) Start Up Pwd

On: Set up the password for start up. You need to input the password to power on the radio.

Off: No password is required for the radio power on start up.





(27-31) Key PF1, PF2, PF3, P1, P2

You can program these keys for different functions.

(33) Time Zone

Set up the time zone of your location.

(34) Date Time

Time Check: Allows to set up the date and time manually. Use the  /  key to set the current year. Move to the month by pushing the  key. Set the month, and use the  key to move forward each step. Once done, click the Menu key to save the date and time.

GPS Check: When GPS is positioning successfully, enter this menu, select GPS check to do the date & time correction automatically.

9. MAIN MENU

9.5.2 Chan Set

The channel set menu will change accordingly to the channel type. When the channel type is digital, it will auto hide the analog menus.

※ Chan Set (Digital Channel)

(1) Channel Type

A-Analog : Set up to analog channel

D- Digital : Set up to digital channel

A+D TX A: Mixed analog, allow receive analog and digital signal, TX is analog.

D+A TX D: Mixed digital, allow receive analog and digital signal, TX is digital.

(2) TX Power

Set up the TX power for current channel.

(3) Band Width

Only narrow band 12.5KHz for digital channel.

(4) RX Freq

Input the RX frequency by keypad, click the Menu key to save, press P2 key to return.

(5) TX Freq

Input the TX frequency by keypad, click the Menu key to save, press P2 key to return.

(6) Talk Around

When the TX radio and RX radio both are set up with Talk Around on, they can communicate directly without a repeater. The analog channel will use the RX frequency as TX/RX frequency, the RX CTCSS/DCS decode as TX CTCSS/DCS encode.

(7) Name

Allow reset the channel name, this function is only valid in channel mode.

(8) TX Permit

Always: Always allow transmit

Channel Free: Allow transmit when the channel is free

Different CC: Allow transmit when receive matched signal but different color code.

9. MAIN MENU

Same CC: Allow transmit when receive matched signal and same color code.

(9) TX Prohibit

TX ON: Will allow transmit on the current channel.

TX OFF: Will not allow transmit on the current channel.

(10) Radio ID

In Digital channel, it will show the DMR ID which must be programmed in the PC software – Digital – DMR ID list- DMR ID. Allows edit and select an ID for the channel, each channel allows one ID.

In Analog channel, it will show the radio self ID which is programmed in PC software – Analog –Analog Address Book – Number.

(11) Colour Code

The digital channel should have the same color code for communication as defined by the repeater to be used; which can be programmed in the PC software or defined in the Menu.

(12) Slot Set

Set up Slot 1 or Slot 2 for the current channel.

(13) Digi Encrypt

With the digital encryption, the communication will be confidential. A total of 32 digital encryptions is offered, and it can be programmed in the PC software or defined in the Menu.

(14) Encrypt Type

Choose normal encryption or enhanced encryption type.

(15) Work Alone

In the PC software – Public – Alarm settings – Work Alone, you have to set up the response time, warn time and response method initially.

Turn on the work alone function for the current channel. When the radios predetermined time has been reached for the alone working time, the radio will beep a sound and show “Work Alone Predict”. The user has to confirm by pushing the programmed work alone key to confirm continuing work alone, otherwise, the radio will start its alarm and send the alarm on the channel when reaching its preset response time.

9. MAIN MENU

※Chan Set (Analog Channel)

When the channel type is analog, it will auto hide the digital menus, instead, the channel set will show the analog menus.

The below listed menus are for analog channel only, other not listed menus are same as the digital channel.

(2) TCDT

Set up the CTCSS/DCS code for the TX.

(3) RCDT

Set up the CTCSS/DCS code for the RX.

(4) RTCDT

Set up the CTCSS/DCS code for both TX and RX

CTCSS code: 62.5Hz~254.1Hz, a total of 51 groups

DCS code: 000N~7771, a total of 1024 groups.

(5) Optional Signal

Allows the set up of DTMF/5TONE/2TONE encode and decode for the analog channels.

(7) Squelch mode

When the analog channel is set up for both CTCSS/DCS decoding and optional signaling, you can set up the RX condition in this menu.

SQ: You can hear the call once the channel receive matched carrier.

CDT: You can hear the call when the channel receive matched CTCSS/DCS signal

TONE: You can hear the call when the channel receives a matched signaling.

C&T: You can hear the call when the channel receives a matched CTCSS/DCS and matched signaling.

C|T: You can hear the call when the channel receives a matched CTCSS/DCS or matched signaling.

(8) Band Width

Choose wide band or narrow band for the analog channel.

(9) Reverse

When this function is enabled, the RX frequency, TX frequency and CTCSS/DCS encode/decode will be reversed.

9. MAIN MENU

(14) Busy Lock

Always: Always allows transmissions

RL: Will not allow transmit when receiving matched carrier but unmatched CTCSS/DCS.

BU: Will not allow transmit when receiving matched carrier.

(15) OWN ID

When the analog channel set up with optional signal, you can check the radio ID number in this menu. The ID number should be set up in PC software – Analog – Analog Address Book.

(17) DTMF Enc

Set a DTMF ID as the default call ID for the current channel.

Press the PTT key to transmit the selected DTMF ID.

Edit the DTMF ID in Menu or with the PC programming software.

(18) 2Tone Enc

Set a 2Tone as the default call ID for the current channel.

Press the PTT key to transmit the selected 2Tone.

Edit the 2Tone in the PC programming software before it can be selected.

(19) 5Tone Enc

Set a 5Tone as the default call ID for the current channel.

Press the PTT key to transmit the selected 5Tone.

Edit the 5Tone in the PC programming software before it can be selected.

9.5.3 Device Info



Show the Radio ID, Radio name, serial number, model name, frequency range, firmware version, radio data version, latest program date, picture version, language version etc.

10. TROUBLE SHOOTING GUIDE

Problems	Solutions
The radio cannot be switched on or no display after being switched on.	<p>A. Battery pack may not be installed properly. Remove the battery pack and install it again.</p> <p>B. Battery power may be insufficient. Recharge or replace the battery pack.</p>
The battery doesn't last very long after charging.	The battery is defective; please replace it with a new battery pack.
Cannot talk to or hear other members in your group.	<ol style="list-style-type: none">1. Make sure the frequency and CTCSS are the same as other members.2. Make sure you are within range, and not too far away from your member.3. Make sure you are set in correct digital mode, and frequency.4. In digital mode, make sure set correct code and encrypt group is used in current channel.5. In digital mode, make sure set correct receiving contacts and receiving group is used.
Other voices from non-group members are heard on the channel.	Analog: Change the CTCSS/DCS tone, and make sure to change the tone on all radios in your group.

11. PROGRAMMING GUIDE

Anytone AT-D868UV radios ship from the manufacturer “Keypad” locked per FCC rules.

You can press the  (Menu) key and the  (star) key to unlock the keypad for the first time of use. You will need the programming cable to connect your radio to your computer for programming.

The programming software and codeplug programming guide are available for download from Anytone website: <http://www.anytone.net/about/about8.html>

When programming this radio for the first time, it is recommended you first READ the radio with the software and then save this file for future reference as it contains the default programming and settings. In addition, after you READ this radio with software, first make your programming and frequency changes, then send this edited file back to your radio.

Multiple Radio ID's

The AT-D868UV radio will allow multiple DMR Radio ID numbers to be used with the radio. This feature will allow one radio to be used for example as a Commercial Radio with its own DMR ID, and at the same time also be used as an Amateur radio with another DMR ID.

In PC software, Digital/ Radio ID List, you can enter your Department Unit Number or Amateur Radio callsign.

Amateur DMR-MARC

For the best Amateur DMR experience obtain a subscriber ID from one of many available

Amateur sources. A U.S. Amateur user can obtain an ID from:

<http://www.dmr-marc.net/cgi-bin/trbo-database/register.cgi>

then scroll down to the user registration button.

Another place to register: <http://register.ham-digital.net/>

For DMR repeaters in your area please see:

<https://www.google.com/maps/d/u/0/viewer?mid=zDtc036qqpwA.kMwk4xZ-Nenc&msa=0>

World DMR repeater network map:

<http://www.dmr-marc.net/repeaters.html>

World DMR repeater network with verified Talkgroups by activity:

<http://dmrx.net/dmrx-map.html>

Worldwide Amateur Contact Database

The AT-D868UV DMR radios contain a separate database memory for importing and displaying Amateur DMR individual IDs, call sign and user name in comma-delimited format (.csv)

Please reference in the programming guide for import and export database operations detailed.

12. ON-LINE SERVICE AND SUPPORT

The Anytone website provides additional information about obtaining service or support for the Anytone line of two-way radios and accessories. Visit: www.anytone.net

Warning Notes

Every effort has been made to ensure that the information in this document is complete, accurate, and up to-date. Anytone Radio assumes no responsibility for the results of errors beyond its control. The manufacturer of this equipment also cannot guarantee that changes in the equipment made by non-authorized users will not affect the information in it.

FCC Licensing Information

This Anytone radio operates on Commercial / Land Mobile frequencies which require a license from the Federal Communications Commission (FCC) for business, personal, education and recreational use. To obtain forms, call the FCC forms hotline at: 1-800-418-3676 or go to <http://www.fcc.gov>

For questions concerning commercial licensing, contact the FCC at 1-888-CALL-FCC(1-888-225-5322).

SAFETY

The Anytone AT-D868UV DMR handheld transceiver has been carefully designed to provide you with years of safe, reliable operation. As with all electrical equipment, however, there are a few basic precautions you should take to avoid hurting yourself or damaging the radio:

- Read the instructions in this handbook carefully. Be sure to save it for future reference.
- Read and follow all warning and instruction labels on the radio and owner's manual.
- Do not carry the transceiver by the antenna. This may damage the antenna or antenna terminal. Grasp the handheld by its base (not the antenna) when you need to place or remove it.
- Do not keep the radio with the antenna very close to, or touching exposed parts of the body, while transmitting. Anytone radios will perform best, if you speak 2-4 inches away from the microphone and the radio is vertical.
- Be sure the "PTT" key is not pressed when you do not need to transmit.
- Do not operate the radio near unshielded electrical blasting caps or in an explosive atmosphere.
- Do not transmit without the antenna fitted on the radio. Though it is provided with a protection, it may damage the TX output final stage.
- Respect the environment conditions. The radio is designed to be used in heavy environments, however avoid exposing it to extremely hot or cold temperature (out of the range between -20 to $+140^{\circ}\text{F}$). Do not expose the transceiver to excessive vibrations as well as dusty or rainy locations.
- Never try to disassemble or service the radio by yourself (aside from the routine maintenance described in this handbook). It may cause damage to the radio transceiver and void your warranty requiring extensive repair work. Always contact your local dealer for assistance.
- Use only authorized accessories. Using non Anytone radio brand accessories may seriously damage your handheld transceiver and void your warranty.
- Do not spill liquid of any kind into your radio. If the transceiver gets wet, immediately dry it by a soft and clean cloth.
- Switch the radio off before you clean it. Follow the directions described in the paragraph "Care and maintenance".

SAFETY

- Handle the battery properly. Never place the LI-ion battery in your pocket or purse with loose coins. This could result in short circuiting the battery.
- Be certain that your power source matches the rating listed for the supplied battery charger (AC adapter). If you are not sure, check with your authorized Anytone dealer.
- Avoid damaging the power cable of the battery charger. Do not step on or place anything on it as this could result in a damaged charger power cord. This product complies with the requirements of the Council Directives 89/336/EEC and 73/23/EEC on the approximation of the laws of the member states relating to electromagnetic compatibility and low voltage.

WARNING

Your wireless hand-held portable transceiver contains a low power transmitter. When the Push-to-Talk (PTT) button is pressed it sends out radio frequency (RF) signals. The device is authorized to operate at a duty factor not to exceed 50% TX and 50% RX.

In August 1996, the Federal Communications Commission (FCC) adopted RF exposure guidelines with safety levels for hand-held wireless devices. To maintain compliance with the FCC's RF exposure guidelines, this transmitter and its antenna must maintain a separation distance of least 2 inches from your face. Speak in a normal voice, with the antenna pointed up and away from the face at the required separation distance. The belt clip is for storage purposes only.

AVOID TRANSMITTING ON HIGH POWER WHILE RADIO IS ATTACHED TO YOUR BELT. To transmit, hold the device away from your body and ensure the antenna is at least 2 inches from your body when transmitting.

13. TECHNICAL SPECIFICATIONS

General		
Frequency Range	136-174MHz (V) , 400-480MHz (U)	
Channel Capacity	4000 channels	
Channel Spacing	25KHz (Wide Band) , 12.5KHz (Narrow Band)	
Phase-locked Step	5KHz, 6.25KHz	
Operating Voltage	7.4V DC $\pm 20\%$ /(2100mAh)	
Frequency Stability	± 2.5 ppm	
Operating Temperature	-20 $^{\circ}$ C ~ +55 $^{\circ}$ C	
Size	129 \times 61 \times 39mm (with battery pack)	
Weight	282g (with battery pack, antenna)	
Receiving Part		
	Wide band	Narrow band
Sensitivity(12dB SINAD)	$\leq 0.25\mu\text{V}$	$\leq 0.35\mu\text{V}$
Digital Sensitivity	0.3uV/-117.4dBm (BER 5%) 0.7uV/-110dBm (BER 1%)	
Adjacent Channel Selectivity	$\geq 70\text{dB}$	$\geq 60\text{dB}$
Spurious Emission	$\leq -57\text{dB}$	$\leq -57\text{dB}$
Spurious Rejection	$\geq 70\text{dB}$	$\geq 70\text{dB}$
Blocking	84db	
Hum & Noise	$\geq 45\text{dB}$	$\geq 40\text{dB}$
Audio Distortion	$\leq 5\%$	
Audio Power Output	1000mW/16 Ω	
Transmitting Part		
	Wide band	Narrow band
Power Output	VHF: 7/5/2.5/1W, UHF: 6/5/2.5/1W	
Modulation	$\pm 5.0\text{KHz}@25\text{KHz}$	$\pm 2.5\text{KHz}@12.5\text{KHz}$
Adjacent Channel Power	$\geq 70\text{dB}$	$\geq 60\text{dB}$
Hum & Noise	$\geq 40\text{dB}$	$\geq 36\text{dB}$
Spurious Emission	$\leq -36\text{dB}$	$\leq -36\text{dB}$
4FSK Digital Modulation	12.5KHz (data) 7K60FXD 12.5KHz (data+voice) 7K60FXE	
Audio Distortion	$\leq 5\%$	
Error rate	$\leq 3\%$	